

# retrofit plaster ring fix 3.0

## installation instruction

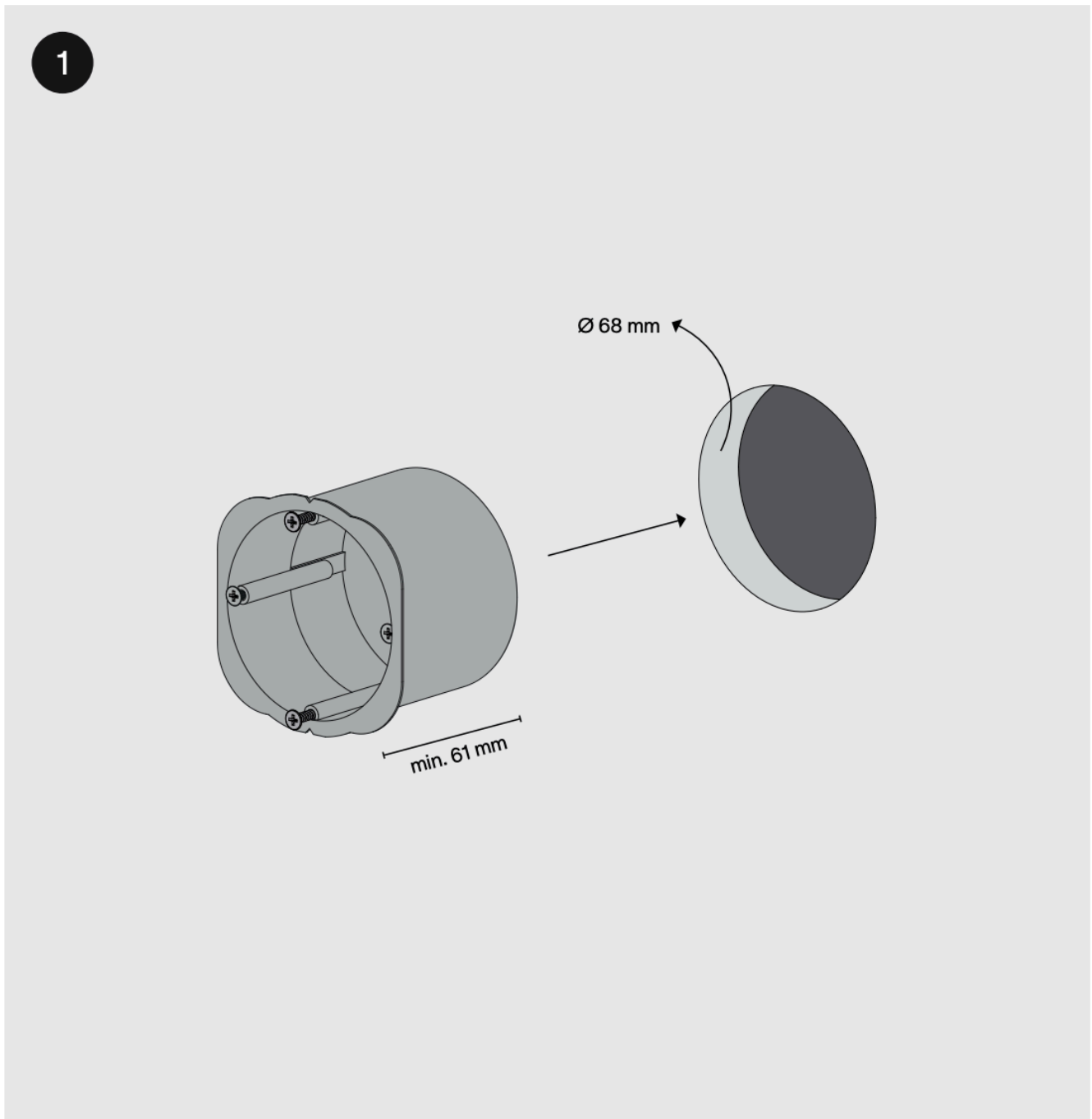

Drill a Ø 68 mm hole and install the junction box in the wall.

or

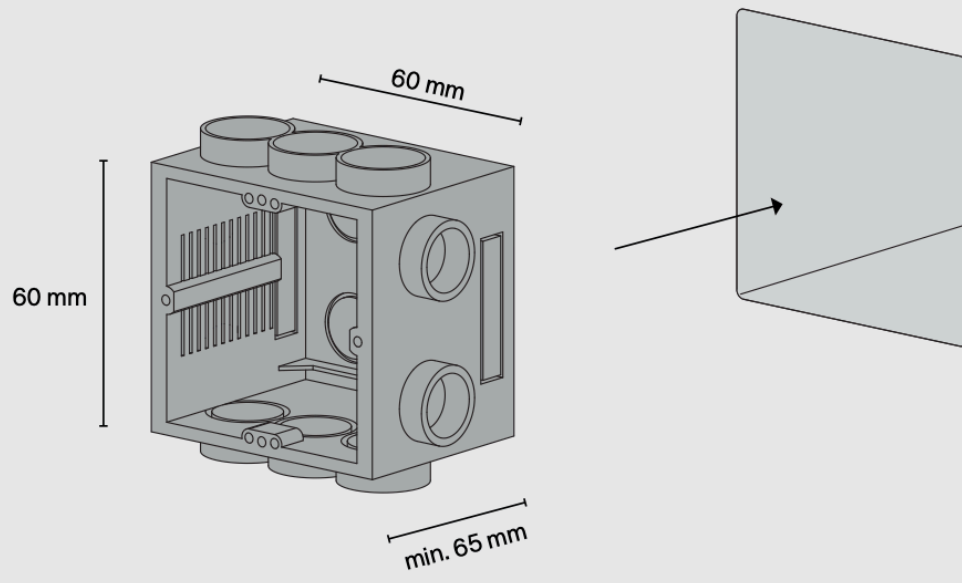

2

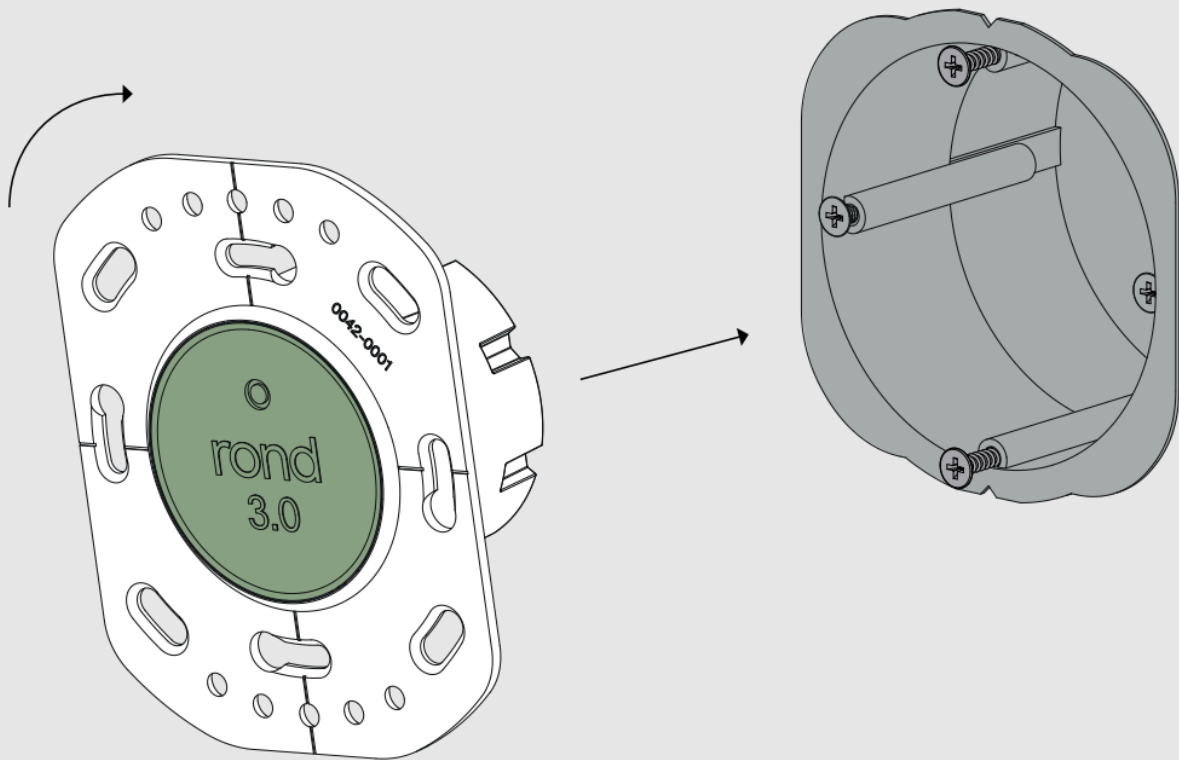

Insert the plaster ring in the junction box and give it a twist.

3

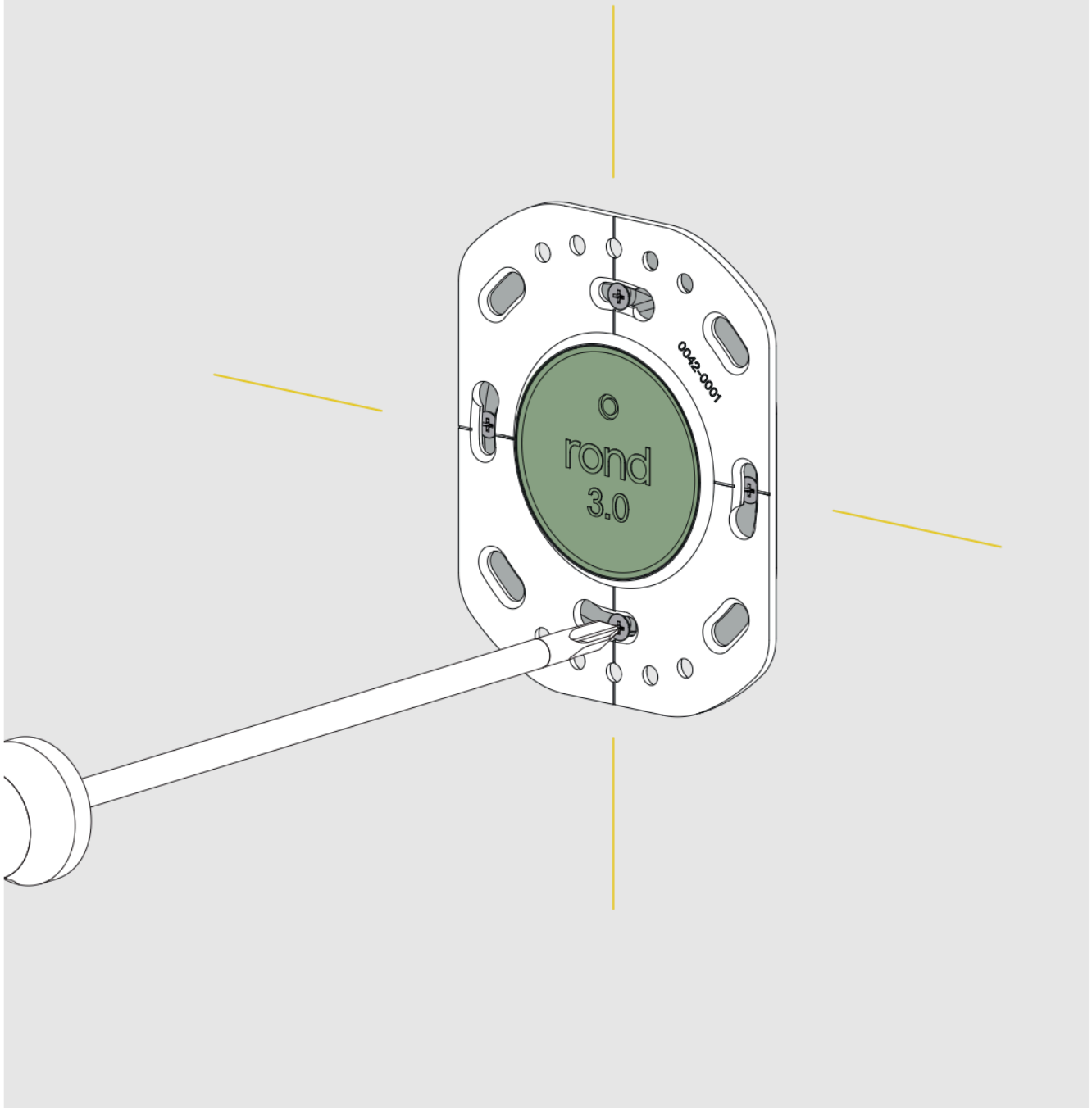

Level and secure the plaster ring to the junction box using the appropriate screws.

4

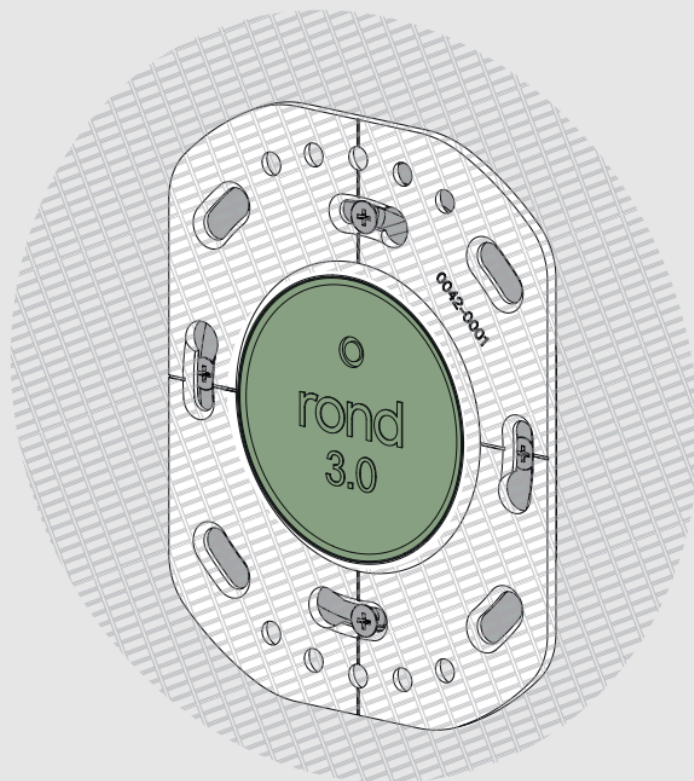

Use a fiberglass mesh tape for optimal plaster adhesion.

5

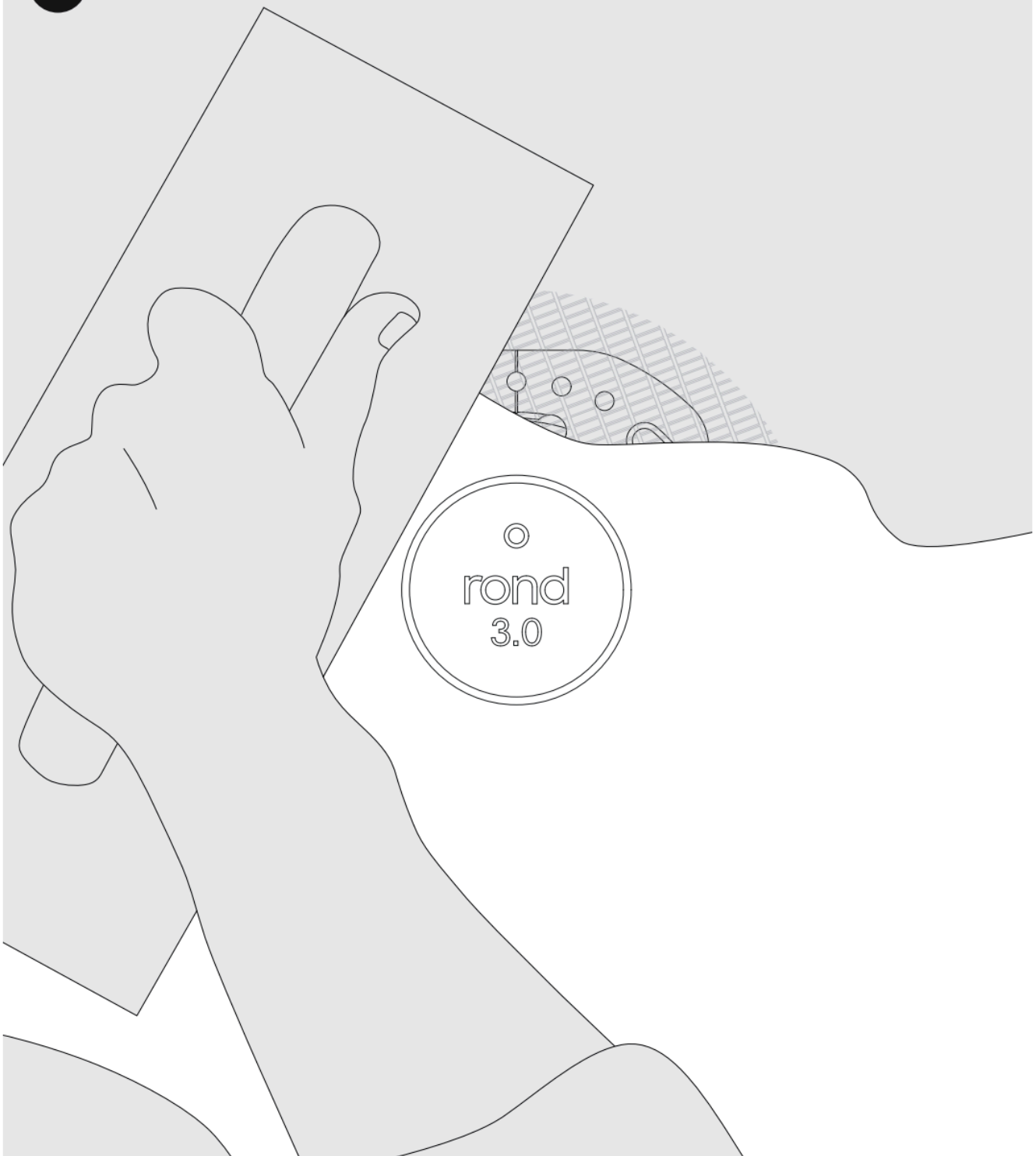

Excercise caution while plastering, do not damage the ring.  
Keep the plaster lid inside the mud ring while plastering.

5

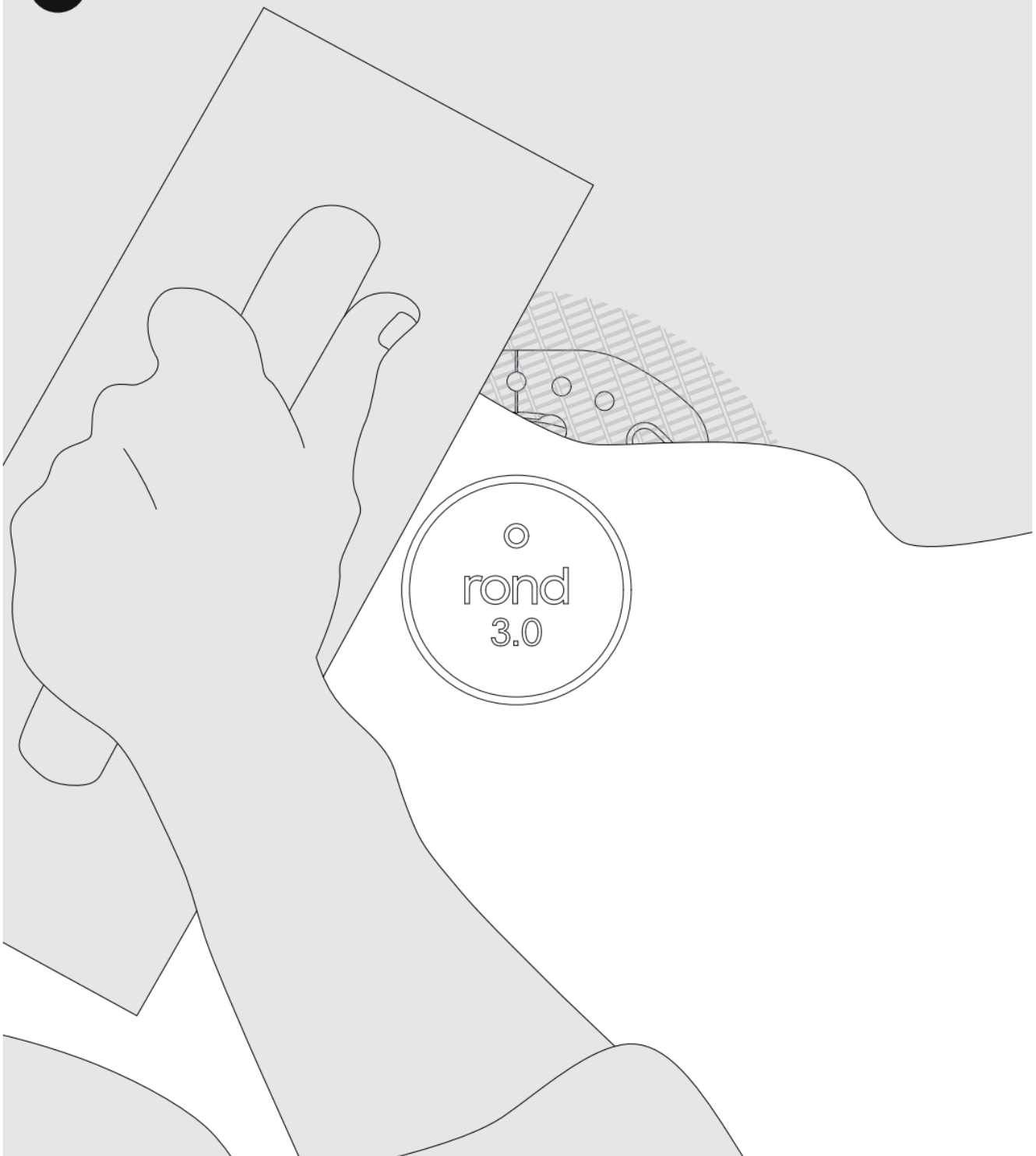

Excercise caution while plastering, do not damage the ring.  
Keep the plaster lid inside the mud ring while plastering.

8

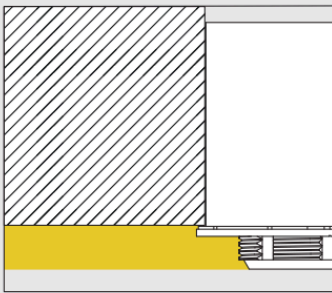

perfect amount of plaster ✓

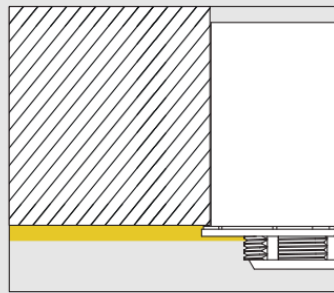

not enough plaster ✗

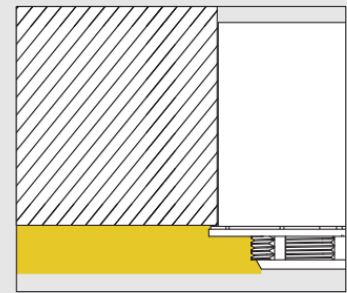

too much plaster ✗

Make sure not to touch the edge of the plate while sanding.

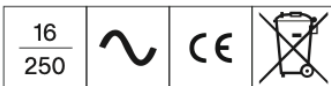

rond.io

Shiver NV - Handelsstraat 19 - 8630 Veurne - Belgium

Installation must be done by skilled professionals only and instructions must be followed at all times. Warranty will not apply in case of wrongful use or if unskilled personnel attempts to repair a product.